



LED INTEGRATED LIGHT MANUFACTURER

LONYUNG®

LONYUNG®
LED INTEGRATED LIGHT MANUFACTURER

LONYUNG LED LIGHTING CO.,LTD

LONYUNG®
LED INTEGRATED LIGHT MANUFACTURER



COMPANY WEBSITE



ALIBABA WEBSITE

Copyright © LONYUNG 2010-2025



Natural Light

Lonyung Better Light

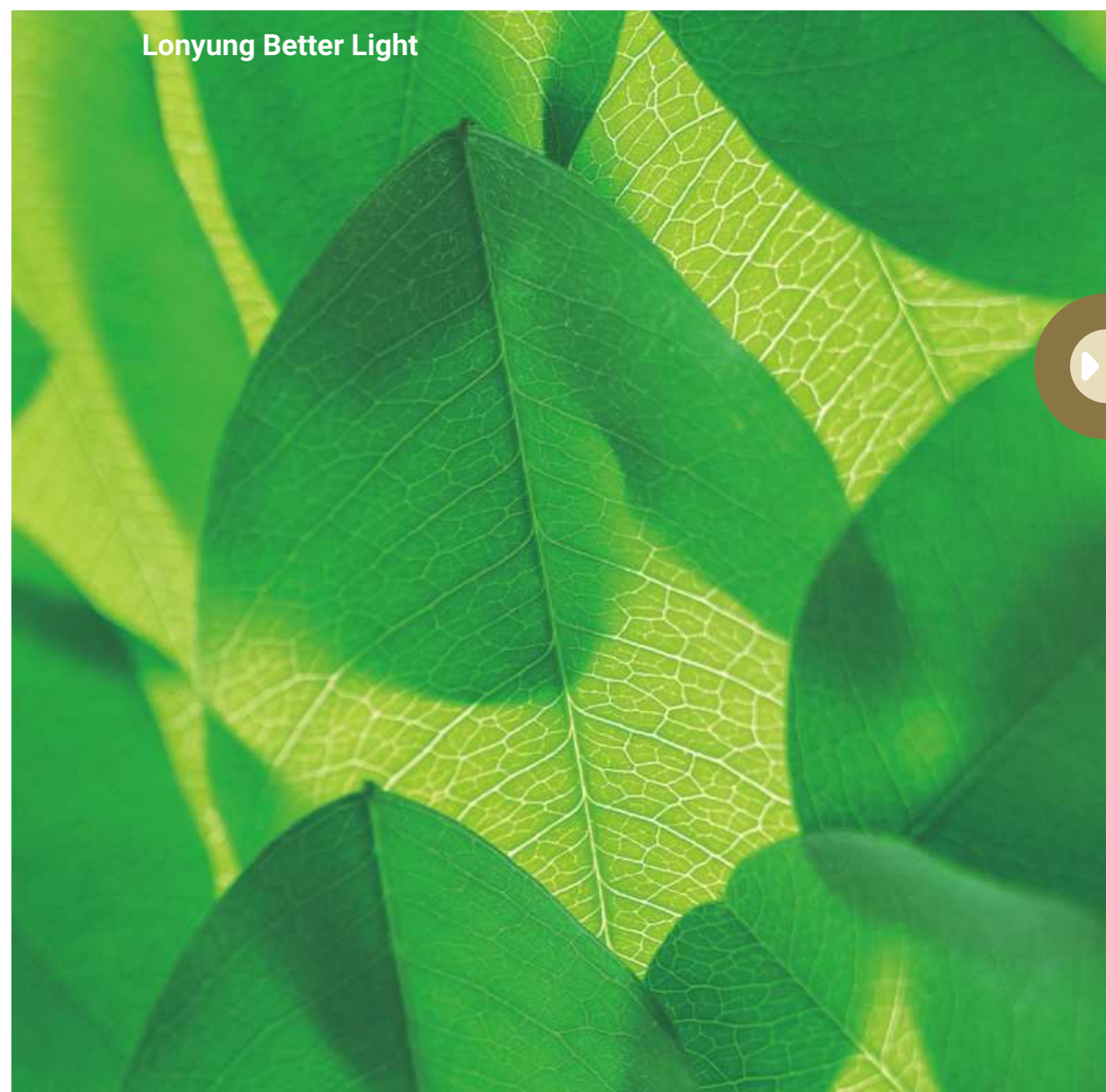

Lonyung Search



Content

LED INTEGRATED LIGHT MANUFACTURER

L	About Lonyung	05-08
O	Featured Products	09-30
N	Led Tri-proof Light Series	31-38
Y	High Bay Fixture Series	39-42
U	Professional Light Series	43-56
N	Led Integrated Light Series	57-70
G	Reddot Award Product	71-74

L	About Lonyung	
■	Lonyung Profile	05
■	Certifications	06
■	Company Culture	07-08

O	Featured Products	
■	Led Linear UP/DOWN Pendant Light	09-12
■	Led Smart RGB Pendant Light	13-14
■	Led Linear Direct Pendent Light	15-16
■	ECO LED LINEAR LAMP	17-18
■	Car workshop light	19-20
■	Led Linear Strip Light	21-22
■	Led Batten Luminaires	23-24
■	Led Batten Light	25-26
■	0-10V Dimming T8 Led Integrated Light	27-28
■	0-10V Dimming Double T5 Integrated Light	29-30

N	Led Tri-proof Light Series	
■	ECO Led Tri-proof Light	31-32
■	Led Tri-proof Light	33-34
■	Mini Led Tri-proof Light	35-36
■	Plastic Led Integrated Light	37-38

Y	High Bay Fixture Series	
■	Led Linear High Bay Light	39-40
■	Led Linear High Bay Fixture	41-42

U	Professional Light Series	
■	Led Cabinet Light (I)	43-44
■	Led Cabinet Light (II)	45-46
■	Magnetic Cabinet Light	47-48
■	Led T8 Tube Light	49-50
■	6CCT & 5Wattage T8 Tube	51-52
■	Led Downlight	53-54
■	Solar Garden Light	55-56

N	Led Integrated Light Series	
■	Led T8 Integrated Light	57-58
■	Single T5 Integrated Light (I)	59-60
■	Single T5 Integrated Light (II)	61-62
■	Double T5 Integrated Light (I)	63-64
■	Double T5 Integrated Light (II)	65-66
■	PC LED T5 Integrated Tube Light	67-68
■	Serial fittings	69-70

G	Reddot Award Product	
■	Led Camping Lantern	71-74

Lonyung Profile

Since 2010

LONYUNG Led Lighting Co.,Ltd. is a high-tech enterprise specialized in the design, development, production and sales of LED lighting products. We were established in 2010 in Zhongshan City.

We are committed to promoting the application of LED lighting products and pay great attention to technological research and innovation. Until now, LONYUNG has obtained 69 patents and takes the lead in passing ISO9001 and BSCI. Our products are certificated under ETL, DLC, TUV-CE, RoHS, SAA, Ip65, Ik10, FCC, PSE.

Our main products include LED integrated tube, LED tri-proof light, LED linear high bay light, LED cabinet light etc. They are widely used in office buildings, houses and industrial areas. We have successfully established long-term partnership with clients from North America, Europe, Australia.

LONYUNG team sincerely welcomes your OEM/ODM requirement. Quality is our spirit. We will always provide you excellent products and services at competitive and reasonable cost. We sincerely invite you to visit us.

Let's make success together.

Certifications

Energy Efficiency Certification



Until now, Lonyung has obtained more than 69 patents. At the same time, our products have approved safety certifications for North America, Europe, Australia and been rewarded with several Germany Red Dot Design Award.





Company Culture

Light Up Your Life



Because Of The Customer

Because the customer has a need,
we have a job to do.

/

Because the customer has a choice,
we must be the better choice.

/

Because the customer has sensibilities,
we must be considerate.

/

Because the customer has an urgency,
we must be quick.

/

Because the customer is unique,
we must be flexible.

/

Because the customer has high expectations,
we must excel.

/

Because the customer has influence,
we have the hope of more customer.

/

Because of the customer,
we exist!



LED LINEAR UP/DOWN PENDANT LIGHT

This is an architectural and commercial style light fixture with an direct and indirect lighting. The light projects 70% of the light output downwards and 30% of the light upwards.

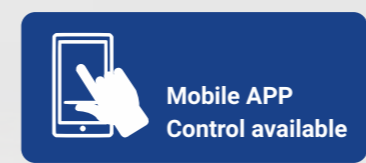



Led Linear UP/DOWN Pendant Light

This is an architectural and commercial style light fixture with an direct and indirect lighting. The light projects 70% of the light output downwards and 30% of the light upwards.



Features

- ☑ Power percentage selectable.
- ☑ Three CCT switchable
- ☑ 0-10V dimming



Product Display



Suspending Accessories

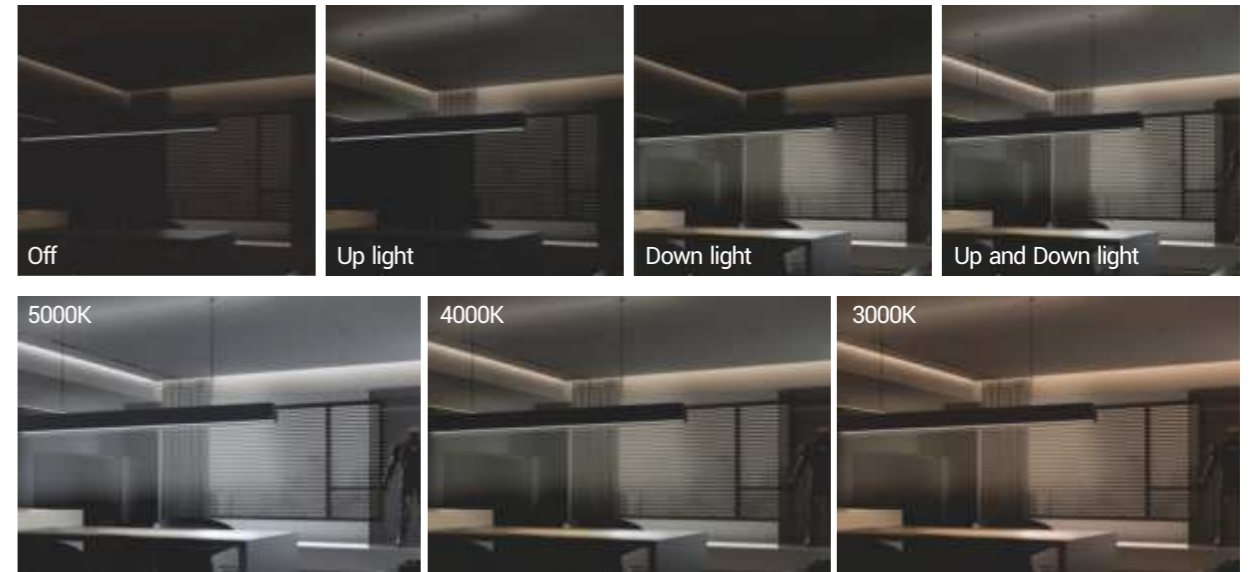

Product Line Drawing (Size:mm)

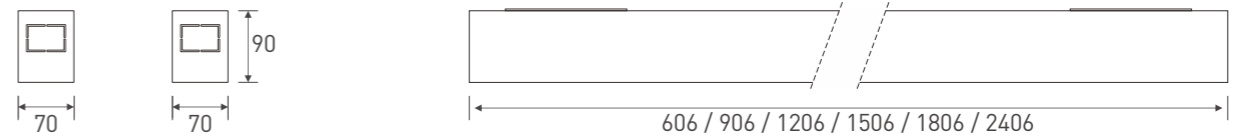

Product Specification

Material : AL+PC	PC Cover : Frosted	CCT : <input type="checkbox"/> 3000K <input type="checkbox"/> 4000K <input type="checkbox"/> 5000K
------------------	--------------------	----------------------------------------------------------------------------------------------------

Model	Size	Power	CRI	Package
LY-SF90L600-30W6	2ft	30W	>80	710*215*245 (mm) 6pcs/ctn
LY-SF90L900-40W6	3ft	40W	>80	1010*215*245 (mm) 6pcs/ctn
LY-SF90L1200-60W6	4ft	60W	>80	1310*215*245 (mm) 6pcs/ctn
LY-SF90L1500-80W6	5ft	80W	>80	1610*215*170 (mm) 4pcs/ctn
LY-SF90L1800-90W6	6ft	90W	>80	1910*215*170 (mm) 4pcs/ctn
LY-SF90L2400-120W6	8ft	120W	>80	2510*115*170 (mm) 2pcs/ctn

Applications: Include any commercial office, school, hotel, hospital or many other architecture.



Led Smart RGB Pendant Light

Deliver 16.8 Million RGB Color with Dynamic Lighting Effects for up light



Features

- ☑ Power percentage selectable.
- ☑ Three CCT switchable
- ☑ 0-10V dimming

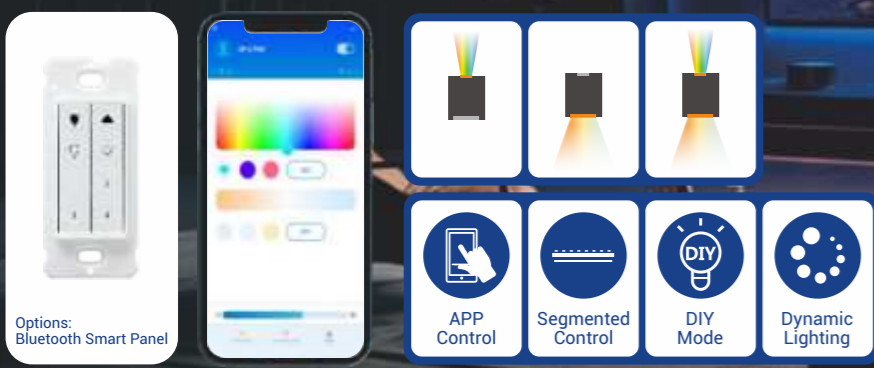
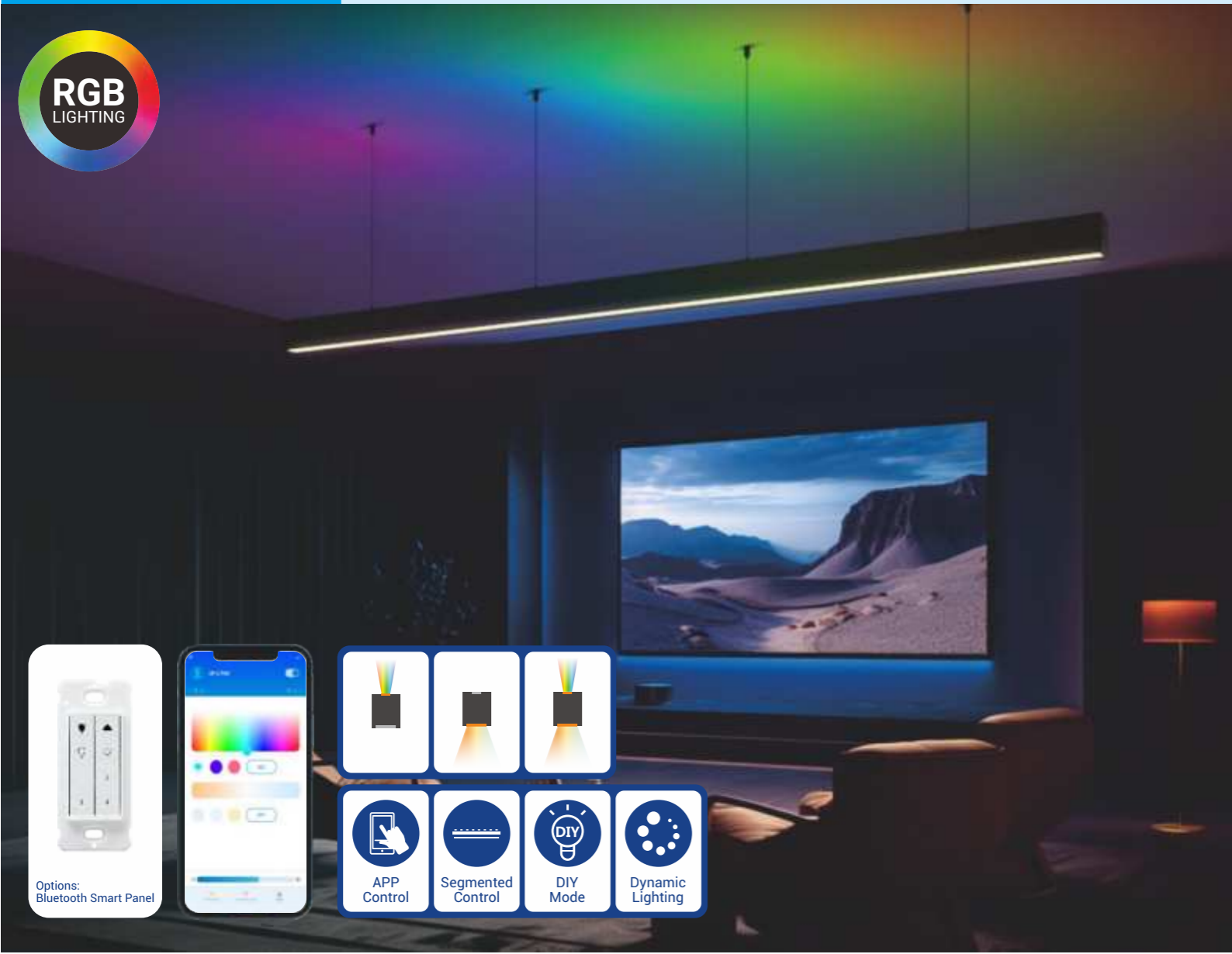

... DOWN Light



... UP Light



... Product Line Drawing (Size:mm)

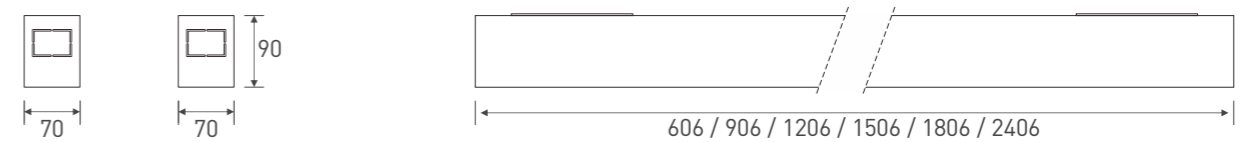

... Product Specification

Model	Size	Power	CRI	Package
LY-SF90L600-30W6	2ft	30W	>80	710*215*245 (mm) 6pcs/ctn
LY-SF90L900-40W6	3ft	40W	>80	1010*215*245 (mm) 6pcs/ctn
LY-SF90L1200-60W6	4ft	60W	>80	1310*215*245 (mm) 6pcs/ctn
LY-SF90L1500-80W6	5ft	80W	>80	1610*215*170 (mm) 4pcs/ctn
LY-SF90L1800-90W6	6ft	90W	>80	1910*215*170 (mm) 4pcs/ctn
LY-SF90L2400-120W6	8ft	120W	>80	2510*115*170 (mm) 2pcs/ctn

... Applications: Include any commercial office, school, hotel, hospital or many other architecture.



Led Linear Direct Pendant Light

A suspended LED linear light with sizes varying from 2ft to 8ft. It is available in white or black finish and with optional square shaped version.



Features

- ☑ Power percentage selectable.
- ☑ Three CCT switchable
- ☑ 600W Seamless Connection



- Frosted
- Honeycomb
- Lens
- Grille

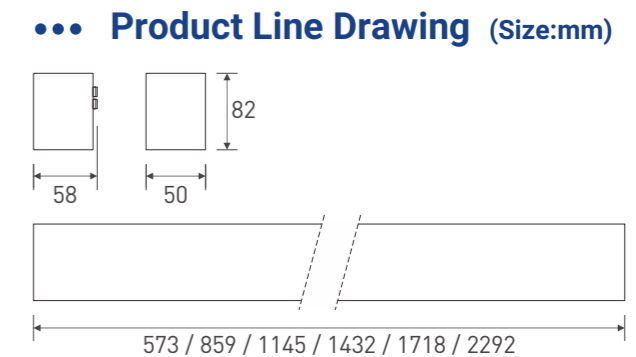
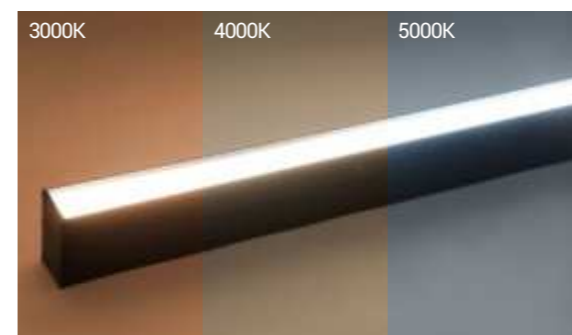

●●● Product Specification

Material : AL+PC	PC Cover : Frosted,Honeycomb,Lens,Grille	CCT : <input type="checkbox"/> 3000K <input type="checkbox"/> 4000K <input type="checkbox"/> 5000K		
Model	Size	Power	CRI	Package
LY-SF90L600-30W6	2ft	30W	>82	680*200*190(mm)6pcs/ctn
LY-SF90L900-40W6	3ft	40W	>82	960*200*190(mm)6pcs/ctn
LY-SF90L1200-60W6	4ft	60W	>82	1250*200*190(mm)6pcs/ctn
LY-SF90L1500-80W6	5ft	80W	>82	1540*200*190(mm)6pcs/ctn
LY-SF90L1800-90W6	6ft	90W	>82	1820*200*190(mm)6pcs/ctn
LY-SF90L2400-120W6	8ft	120W	>82	2400*140*190(mm)4pcs/ctn

●●● Applications: Include any commercial office, school, hotel, hospital or many other architecture.



ECO LED LINEAR LAMP

Eco LED Linear Light is a special linear lighting product provide bright lights in targeted areas, which gives a perfect solution for office,subway station,super market and airport sectors.



Features

- ☑ Specifiable color temperature.
- ☑ Integral specifiable dimmable drivers or PoE.
- ☑ 600W Seamless Connection



Product Line Drawing (Size:mm)

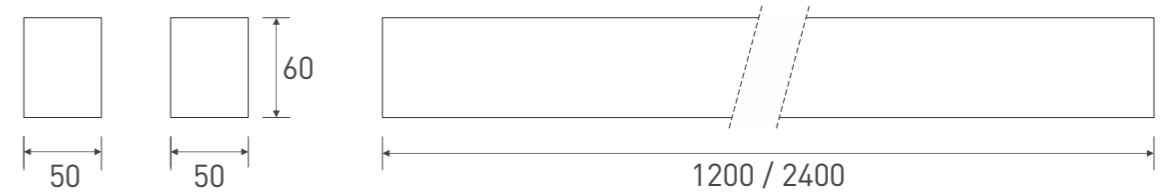

Product Specification

Material : AL+PC	PC Cover : Frosted	CCT : <input type="checkbox"/> 3000K <input type="checkbox"/> 4000K <input type="checkbox"/> 5000K
------------------	--------------------	----------------------------------------------------------------------------------------------------

Model	Size	Power	CRI	Package
LY-SF90L1200-40W6	4ft	60W	>82	1250*200*190(mm)6pcs/ctn
LY-SF90L2400-80W6	8ft	80W	>82	2400*140*190(mm)4pcs/ctn

Product Display



Round shape canopy



Suspending Accessories



Sold separately



Applications: Include any commercial office, school, hotel, hospital or many other architecture.



Car workshop light

Led Garage Light DIY Linkable Colorful Ambient Honeycomb Lighting for Car Detailing Shop



Features

- ☑ 2 pins design would be better for the stability of the whole structure
- ☑ It will lock the connector and tubes automatically
- ☑ Fireproof PVC, good at light transmitting;

14 honeycomb Options



5 honeycomb Options

Product Line Drawing (Size:mm)

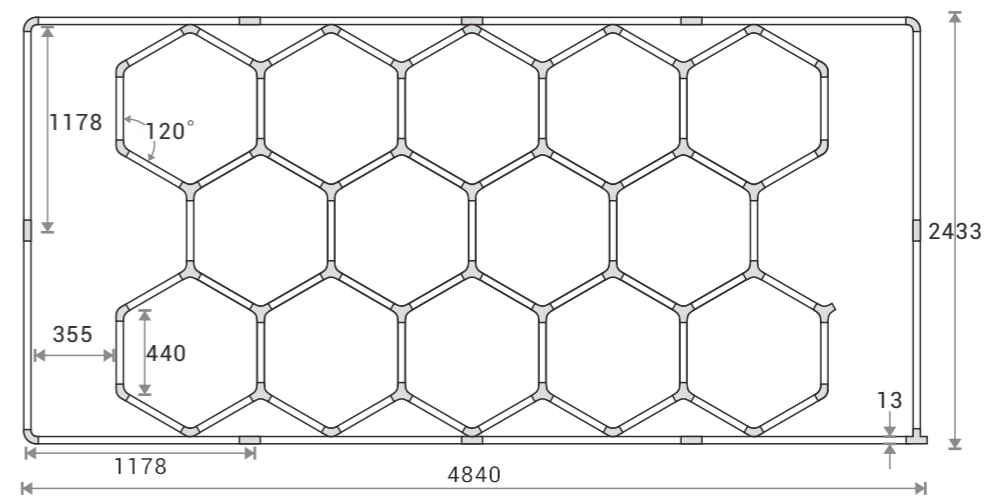
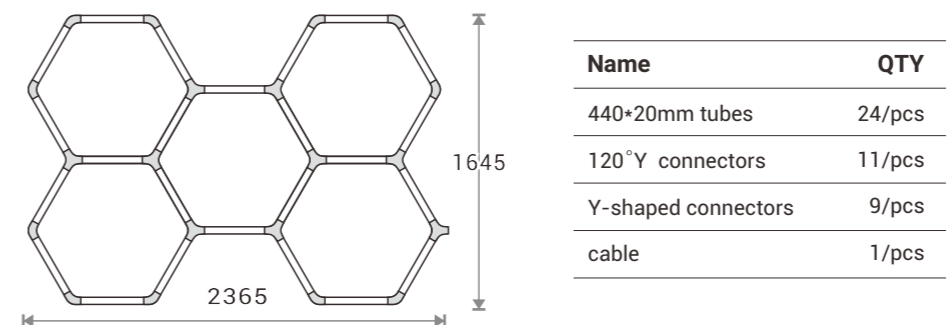

Product Specification

Material : AL+PC	PC Cover : Frosted	CCT : □6500K
-------------------------	---------------------------	---------------------

Name	Specification	QTY	Name	Specification	QTY
440*20mm tubes	Power: 6w	57/pcs	T-shaped connectors	3-way white	1pcs
1178*20mm tubes	Power: 16w	12/pcs	Y-shaped connectors	2-way white	17/pcs
90° connectors	2-way white	3/pcs	120° Y connectors	2-way white	27/pcs
180° connectors	2-way white	8/pcs	cable	0.3m 1-end	2/pcs

Connectors





Led Linear Strip Light

This is a LED Linear light that combined with non dimmable and 0-10V dimming. It can meet the challenges of your industrial, shops, warehouse and task lighting need.



Features

- ☑ Connected up to 600W in a line
- ☑ 0-10V dimming optional
- ☑ Seamless & No Dark in-line connection



Emergency light



Product Line Drawing (Size:mm)

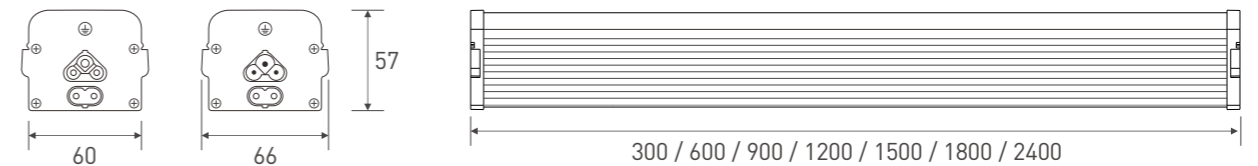

Product Specification

Material : AL+PC	PC Cover : Frosted / Clear	CCT : <input type="checkbox"/> 3000K <input type="checkbox"/> 4000K <input type="checkbox"/> 5000K
------------------	----------------------------	----------------------------------------------------------------------------------------------------

Model	Size	Power	CRI	Package
LY-SF90L300-15W2	1ft	15W	>80	490*225*205 (mm) 9pcs/ctn
LY-SF90L600-30W2	2ft	30W	>80	790*225*205 (mm) 9pcs/ctn
LY-SF90L900-40W2	3ft	40W	>80	1090*225*205 (mm) 9pcs/ctn
LY-SF90L1200-60W2	4ft	60W	>80	1390*225*205 (mm) 9pcs/ctn
LY-SF90L1500-80W2	5ft	80W	>80	1690*225*205 (mm) 9pcs/ctn
LY-SF90L1800-90W2	6ft	90W	>80	1990*155*145 (mm) 4pcs/ctn
LY-SF90L2400-120W2	8ft	120W	>80	2590*155*145 (mm) 4pcs/ctn

Applications: Include Warehousing, Manufacturing, Gymnasiums, And Other Large Indoor Spaces

Product Display



Accessories





Led Batten Light

Elegant Design, Unique 3 Rows Light



Features

- ☑ Batten Lampshade
- ☑ Smooth And Uniform Light
- ☑ Seamless / No-dark Connection



■ Seamless Connection

■ CCT Adjustable

■ On/Off Switch

■ Straight Connector



Product Line Drawing (Size:mm)

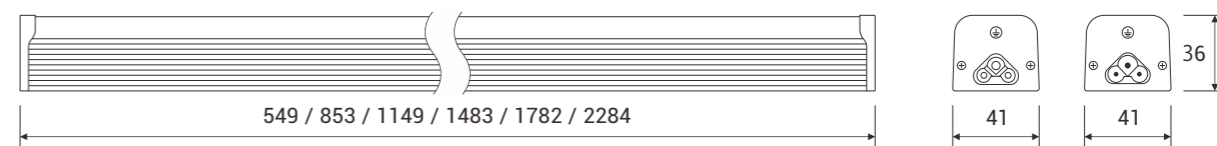

Wiring Method

Single Wired

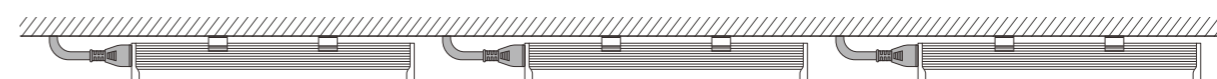

Linkable

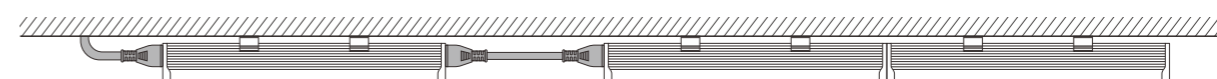

Product Specification

Material : AL+PC	PC Cover : Frosted / Clear	CCT : <input type="checkbox"/> 3000K <input type="checkbox"/> 4000K <input type="checkbox"/> 5000K <input type="checkbox"/> 6000K
------------------	----------------------------	-----------------------------------------------------------------------------------------------------------------------------------

Model	Size	Power	CRI	Beam Angle	Package
LY-T5SL600-15W	2ft	15W	>80	120	710*260*180 (mm) 20pcs/ctn
LY-T5SL900-25W	3ft	25W	>80	120	1015*260*180 (mm) 20pcs/ctn
LY-T5SL1200-30W	4ft	30W	>80	120	1310*260*180 (mm) 20pcs/ctn
LY-T5SL1200-40W	4ft	40W	>80	120	1310*260*180 (mm) 20pcs/ctn
LY-T5SL1500-40W	5ft	40W	>80	120	1645*210*180 (mm) 16pcs/ctn
LY-T5SL1800-44W	6ft	44W	>80	120	1945*210*180 (mm) 16pcs/ctn
LY-T5SL2400-60W	8ft	60W	>80	120	2445*160*146 (mm) 9pcs/ctn

Applications: Commercial Buidling, Library, Lobby, Hall etc



0-10V Dimming T8 Led Integrated Light

Fixed Forever Once Locked, Never Worry About Electricity Leaking
Low UGR Integrated Lighting



Features

- ☑ 0-10V Dimming
- ☑ Fall-away Prevention Design
- ☑ Self Locking Buckle Linkable



Self-locking Buckle Connection

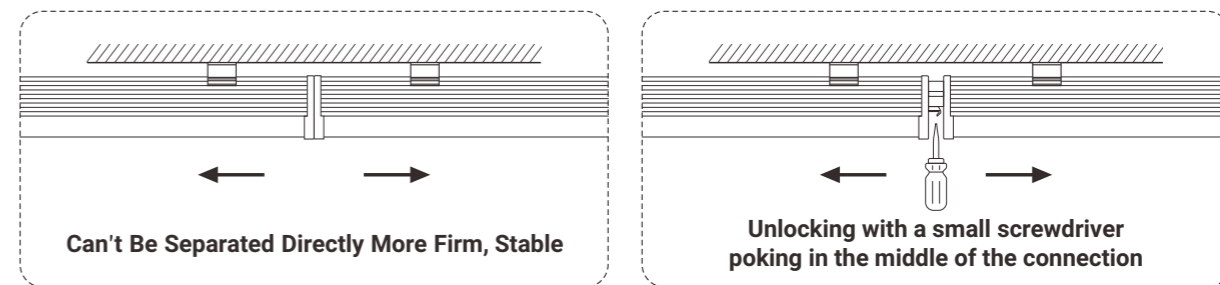

Product Line Drawing (Size:mm)

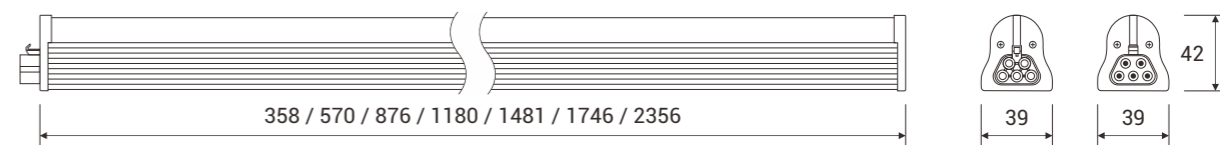

Product Specification

Material : AL+PC	PC Cover : Frosted / Clear	CCT : ■ 3000K ■ 4000K ■ 5000K ■ 6000K
------------------	----------------------------	---------------------------------------------------------------------------------------------------------------------------------------------------------------------------------------------------

Model	Size	Power	CRI	Beam Angle	Package
LY-T8DL600-9W	2ft	9W	>80	120	900*240*205 (mm) 20pcs/ctn
LY-T8DL900-13W	3ft	13W	>80	120	1205*240*205 (mm) 20pcs/ctn
LY-T8DL1200-18W	4ft	18W	>80	120	1510*240*205 (mm) 20pcs/ctn
LY-T8DL1200-22W	4ft	22W	>80	120	1510*240*205 (mm) 20pcs/ctn
LY-T8DL1500-25W	5ft	25W	>80	120	1810*240*205 (mm) 20pcs/ctn
LY-T8DL2400-44W	8ft	44W	>80	120	2685*150*120 (mm) 6pcs/ctn

Applications: Factories, Food Storage, Office Buildings, Hotels etc

Connection Ways



Self-Locking

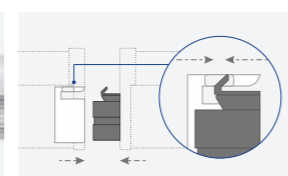

End Cap



Standard Clip





0-10V Dimming Double T5 Integrated Light

Enjoy Hassle-free, safe and easy Installation, Low UGR Integrated Lighting



Features

- ✓ Patent Male-female linkable design
- ✓ Maximum tandem wattage: 300W optional
- ✓ Seamless & No Dark in-line connection



••• Installation

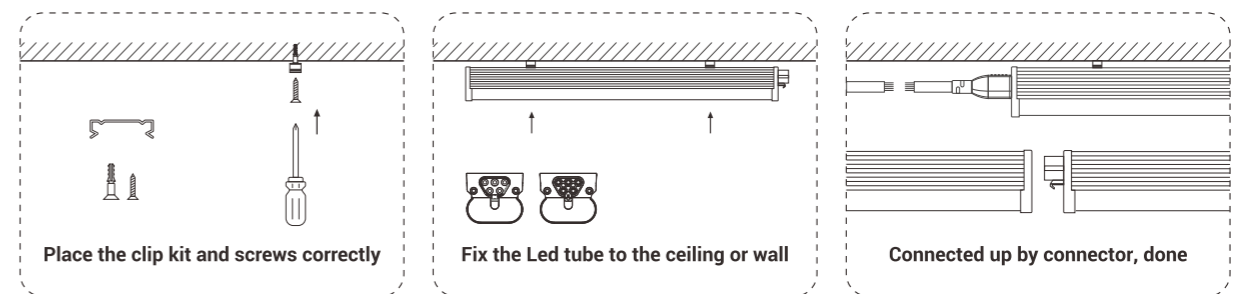

••• Product Line Drawing (Size:mm)

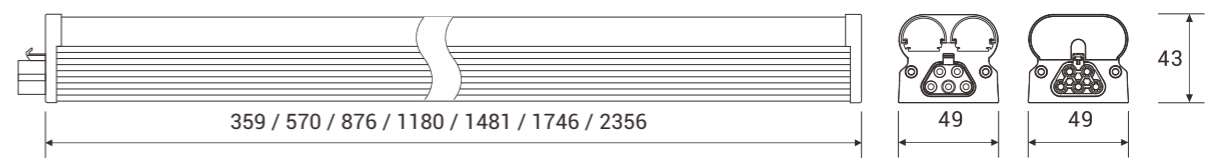

••• Product Specification

Material : AL+PC	PC Cover : Frosted / Clear	CCT : ■ 3000K ■ 4000K ■ 5000K ■ 6000K
-------------------------	-----------------------------------	-------------------------------------------------------------------------------------------------------------------------------------------------------------------------------------------

Model	Size	Power	CRI	Package
LY-T5SL300-8W	1ft	8W	>82	690*280*210(mm) 20pcs/ctn
LY-T5SL600-15W	2ft	15W	>82	900*280*210(mm) 20pcs/ctn
LY-T5SL900-25W	3ft	25W	>82	1205*280*210(mm) 20pcs/ctn
LY-T5SL1200-30W	4ft	30W	>82	1510*280*210(mm) 20pcs/ctn
LY-T5SL1200-40W	4ft	40W	>82	1510*280*210(mm) 20pcs/ctn
LY-T5SL1500-40W	5ft	40W	>82	1810*230*210(mm) 16pcs/ctn
LY-T5SL1800-44W	6ft	44W	>82	2070*230*210(mm) 16pcs/ctn
LY-T5SL2400-60W	8ft	60W	>82	2685*175*120(mm) 6pcs/ctn
LY-T5SL2400-80W	8ft	80W	>82	2685*175*120(mm) 6pcs/ctn

••• Applications: Supermarkets, Office, Hotel, shopping malls etc

■ Connection Ways



■ Self-Locking



■ Led type

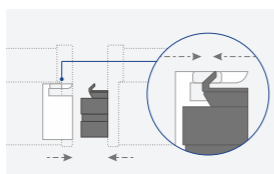

■ Installation Kits





ECO Led Tri-proof Light

Economic Solution For Led Tri-proof Light



Features

- ✓ IP65 Water-proof, Dust-proof, Pressure-proof
- ✓ 600w Connection
- ✓ 0-10v Dimming Optional



Product Line Drawing (Size:mm)

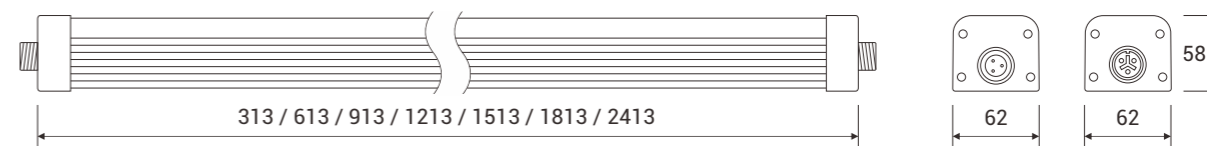

Product Specification

Material : AL+PC PC Cover : Frosted / Clear CCT : ■ 3000K ■ 4000K ■ 5000K ■ 6000K

Model	Size	Power	CRI	Beam Angle	Package
LY-SF90L300-20W	1ft	20W	>80	120	490x225x205 (mm) 9pcs/ctn
LY-SF90L600-30W	2ft	30W	>80	120	790x225x205 (mm) 9pcs/ctn
LY-SF90L900-40W	3ft	40W	>80	120	1090x225x205 (mm) 9pcs/ctn
LY-SF90L1200-60W	4ft	60W	>80	120	1390x225x205 (mm) 9pcs/ctn
LY-SF90L1500-80W	5ft	80W	>80	120	1690x225x205 (mm) 9pcs/ctn
LY-SF90L1800-90W	6ft	90W	>80	120	1990x155x145 (mm) 4pcs/ctn
LY-SF90L2400-120W	8ft	120W	>80	120	2590x155x145 (mm) 4pcs/ctn

Applications: Warehouse, Airport, Factory, Indoor Stadium etc

■ Linkable



■ Non-Linkable



■ Connection Cable



■ Power Cord





Led Tri-proof Light

Extremely Safe Lighting In Various Situations



Features

- ☑ Water-proof
- ☑ Dust-proof
- ☑ Pressure-proof



Product Line Drawing (Size:mm)

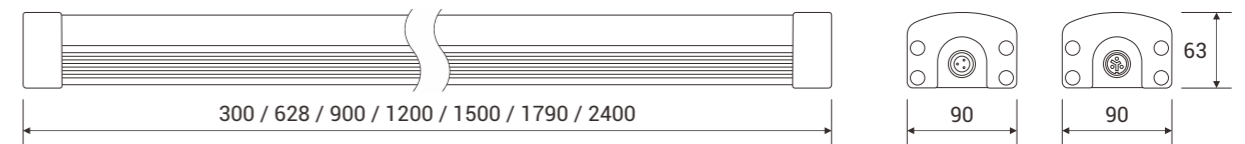

Product Specification

Material : AL+PC PC Cover : Frosted / Clear striped CCT : 3000K 4000K 5000K 6000K

Model	Size	Power	CRI	Beam Angle	Package
LY-SF90L300-20W	1ft	20W	>80	120	550*205*220 (mm) 6pcs/ctn
LY-SF90L600-30W	2ft	30W	>80	120	880*205*220 (mm) 6pcs/ctn
LY-SF90L900-40W	3ft	40W	>80	120	1150*205*220 (mm) 6pcs/ctn
LY-SF90L1200-60W	4ft	60W	>80	120	1450*205*220 (mm) 6pcs/ctn
LY-SF90L1500-80W	5ft	80W	>80	120	1750*205*220 (mm) 6pcs/ctn
LY-SF90L1800-90W	6ft	90W	>80	120	2040*205*155 (mm) 4pcs/ctn
LY-SF90L2400-120W	8ft	120W	>80	120	2650*110*155 (mm) 2pcs/ctn

- Linkable
- Junction-Box mounted
- Suspending
- Standard Clip



Applications: Underground Parking Lot, Garage, Tunnel, Metro Station etc



Mini Led Tri-proof Light

Economic Solution For Led Tri-proof Light



Features

- ☑ Water-proof
- ☑ Dust-proof
- ☑ Connect Up To 600w



Product Line Drawing (Size:mm)

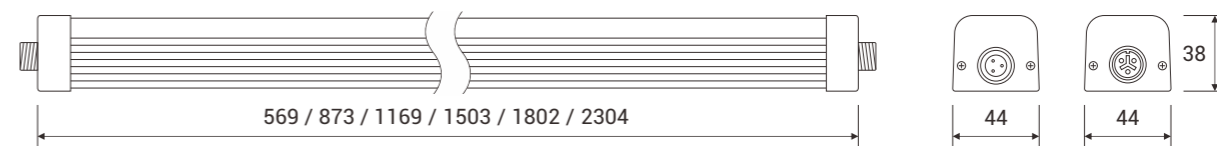

Product Specification

Material : AL+PC	PC Cover : Frosted / Clear	CCT : ■ 3000K ■ 4000K ■ 5000K ■ 6000K
------------------	----------------------------	----------------------------------------------------------------------------------------------------------------------------------------------------------------------------------------

Model	Size	Power	CRI	Beam Angle	Package
LY-T5SL600-15W(M)	2ft	15W	>80	120	710*260*180 (mm) 20pcs/ctn
LY-T5SL900-25W(M)	3ft	25W	>80	120	1015*260*180 (mm) 20pcs/ctn
LY-T5SL1200-30W(M)	4ft	30W	>80	120	1310*260*180 (mm) 20pcs/ctn
LY-T5SL1200-40W(M)	4ft	40W	>80	120	1310*260*180 (mm) 20pcs/ctn
LY-T5SL1500-40W(M)	5ft	40W	>80	120	1645*210*180 (mm) 16pcs/ctn
LY-T5SL1800-44W(M)	6ft	44W	>80	120	1945*210*180 (mm) 16pcs/ctn
LY-T5SL2400-60W(M)	8ft	60W	>80	120	2445*160*146 (mm) 9pcs/ctn

Linkable



Non-Linkable



Connection Cable



Power Cord



Applications: Warehouse, Airport, Factory, Indoor Stadium etc

Plastic Led Integrated Light

Good Lighting Products, LONYUNG Created



Features

- ✓ Cost-Effective
- ✓ IP66 Rating
- ✓ 180° Beam Angle



Product Line Drawing (Size:mm)

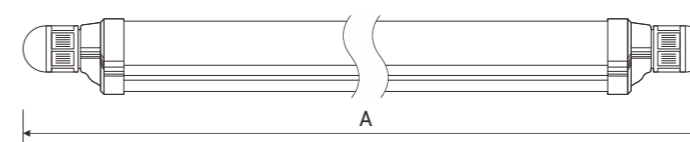
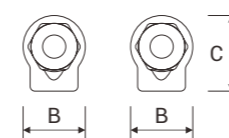

A	B	C
637	33	40
944	33	40
1247	33	40
1547	33	40

Product Specification

Material : PC	PC Cover : Frosted / Clear	CCT : ■ 3000K ■ 4000K ■ 5000K ■ 6000K
---------------	----------------------------	----------------------------------------------------------------------------------------------------------------------------------------------------------------------------------------

Model	Size	Power	CRI	Beam Angle	Package
LY-T8DL600-9WP	2ft	9W	>80	180	830*240*220 (mm) 25pcs/ctn
LY-T8DL900-13WP	3ft	13W	>80	180	1135*240*220 (mm) 25pcs/ctn
LY-T8DL1200-18WP	4ft	18W	>80	180	1440*240*220 (mm) 25pcs/ctn
LY-T8DL1500-22WP	5ft	22W	>80	180	1740*240*220 (mm) 25pcs/ctn

■ Linkable



■ Non-Linkable



■ Waterproof connection



■ Standard Clip



••• Applications: Refrigerator, Fridge, Icebox, Cooler, Storeroom, Aquarium etc



Led Linear High Bay Light

Compact Tough, Reliable And Safety



Features

- ✓ Wider Luminous Area
- ✓ 1.3mm Aluminum Housing
- ✓ IP65 Water-proof & Dust-proof



••• Installation Ways

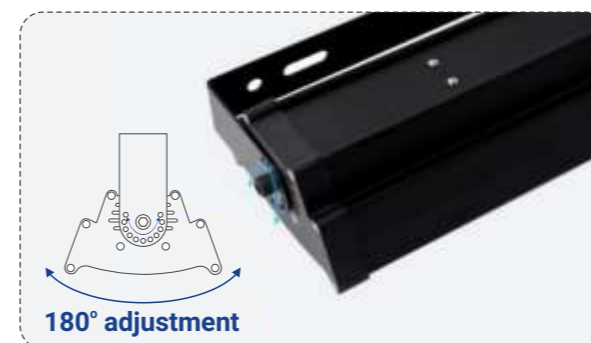

••• Highly efficient led light



••• Product Line Drawing (Size:mm)

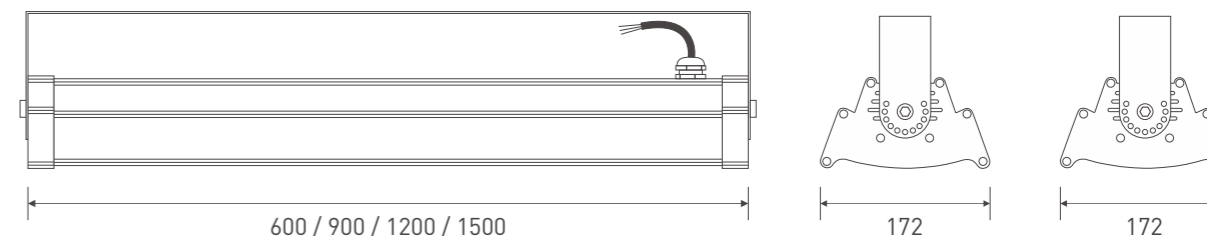

••• Product Specification

Material : AL+PC	PC Cover : Frosted / Clear	CCT : <input type="checkbox"/> 3000K <input type="checkbox"/> 4000K <input type="checkbox"/> 5000K <input type="checkbox"/> 6000K
------------------	----------------------------	-----------------------------------------------------------------------------------------------------------------------------------

Model	Size	Power	Lumens	CRI	Package
LY-HB180L600-100W	2ft	100W	135lm/w	>80	655*220*170 (mm) 1pc/ctn
LY-HB180L900-150W	3ft	150W	135lm/w	>80	955*220*170 (mm) 1pc/ctn
LY-HB180L1200-200W	4ft	200W	135lm/w	>80	1255*220*170 (mm) 1pc/ctn
LY-HB180L1500-240W	5ft	240W	135lm/w	>80	1555*220*170 (mm) 1pc/ctn

■ Product Display



■ Power Cable



■ Accessories



••• Applications: Workshop, Cold Storage, Facilities, Railway, Train Station etc

Led Cabinet Light (I)

For Greater Kitchen Lighting Improvements



Features

- ✓ Easy Installation
- ✓ Seamless Connection
- ✓ Under Cabinet Lighting



■ Seamless Connection



■ Connecting Cable



■ Straight Connector



On/Off Switch



CCT Adjustable



Power Cord with Plug

Product Line Drawing (Size:mm)

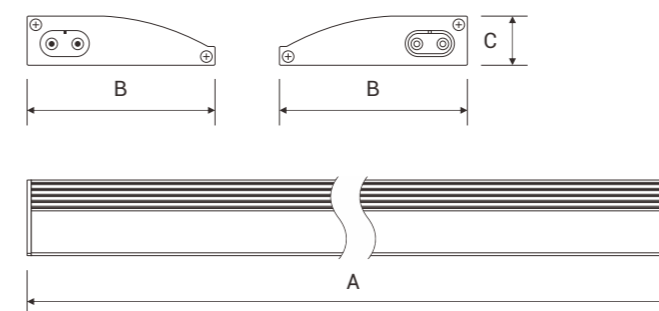

A	B	C
356	65	17
567	65	17
874	65	17
1177	65	17

Product Specification

Material : AL+PC	PC Cover : Frosted	CCT : <input type="checkbox"/> 3000K <input type="checkbox"/> 4000K <input type="checkbox"/> 5000K <input type="checkbox"/> 6000K
------------------	--------------------	-----------------------------------------------------------------------------------------------------------------------------------

Model	Size	Power	CRI	Package
LY-CG65L300-4W	1ft	4W	>80	540*165*250 (mm) 20pcs/ctn
LY-CG65L600-7W	2ft	7W	>80	750*165*250 (mm) 20pcs/ctn
LY-CG65L900-12W	3ft	12W	>80	1060*165*250 (mm) 20pcs/ctn
LY-CG65L1200-15W	4ft	15W	>80	1360*165*250 (mm) 20pcs/ctn
LY-CG65L1200-20W	4ft	20W	>80	1360*165*250 (mm) 20pcs/ctn

Applications: Under And Over Cabinets, Display Cases, Task Lighting, Work Areas etc

Led Cabinet Light (II)

Square Design, Light Up Your Life



Features

- ☑ Square Design
- ☑ Seamless Connection
- ☑ Under Cabinet Lighting



Product Line Drawing (Size:mm)

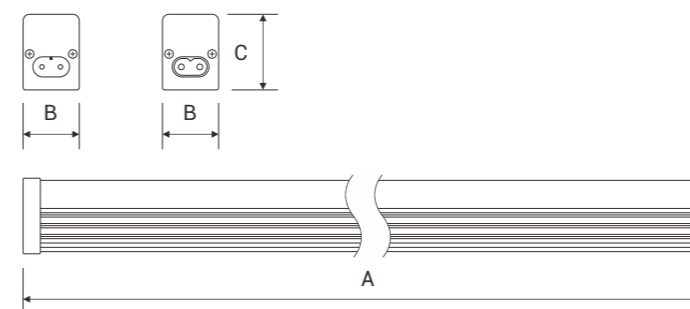

A	B	C
360	26	35
571	26	35
878	26	35
1181	26	35

Product Specification

Material : AL+PC	PC Cover : Frosted / Clear	CCT : <input type="checkbox"/> 3000K <input type="checkbox"/> 4000K <input type="checkbox"/> 5000K <input type="checkbox"/> 6000K
------------------	----------------------------	-----------------------------------------------------------------------------------------------------------------------------------

Model	Size	Power	CRI	Beam Angle	Package
LY-T5FL300-4W	1ft	4W	>80	120	570*200*230 (mm) 25pcs/ctn
LY-T5FL600-7W	2ft	7W	>80	120	780*200*230 (mm) 25pcs/ctn
LY-T5FL900-12W	3ft	12W	>80	120	1085*200*230 (mm) 25pcs/ctn
LY-T5FL1200-15W	4ft	15W	>80	120	1390*200*230 (mm) 25pcs/ctn
LY-T5FL1200-20W	4ft	20W	>80	120	1390*200*230 (mm) 25pcs/ctn

Connection



Connecting Cable



Straight Connector



Standard Clip



Applications: Under And Over Cabinets, Display Cases, Task Lighting, Work Areas etc

Magnetic Cabinet Light

3CCT Motion Sensor Battery Powered Dimmable Rechargeable LED Light



Features

- ✓ Intelligent sensing
- ✓ Slim and compact
- ✓ Easy Installation



- Intelligent sensing
- Slim and compact
- Type C charging
- Magnetic Light Bar

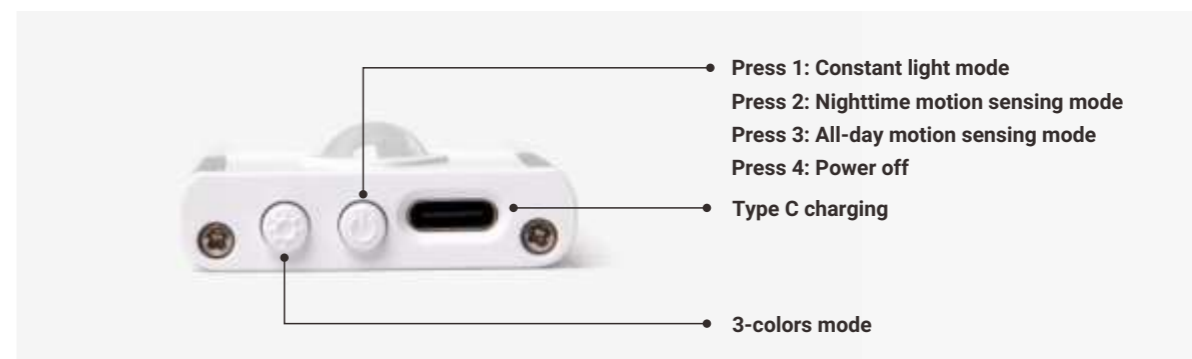

Product Line Drawing (Size:mm)

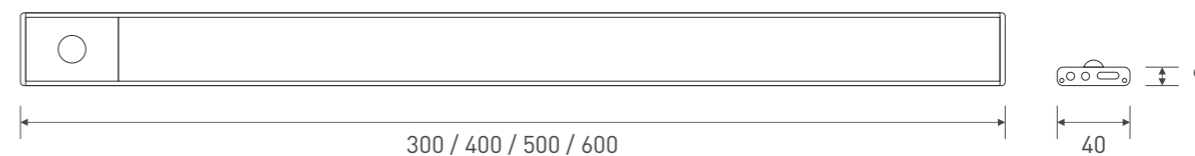

Product Specification

Material : AL+PC	PC Cover : Frosted	CCT : <input type="checkbox"/> 3000K <input type="checkbox"/> 4000K <input type="checkbox"/> 5000K <input type="checkbox"/> 6000K
------------------	--------------------	-----------------------------------------------------------------------------------------------------------------------------------

Model	Size	Power	CRI	Battery	Package
LY-CG40L300	0.3m	1.0W	>80	600mA	365*150*230 (mm) 30pcs/ctn
LY-CG40L400	0.4m	1.3W	>80	800mA	465*150*230 (mm) 30pcs/ctn
LY-CG40L500	0.5m	1.5W	>80	1000mA	565*150*230 (mm) 20pcs/ctn
LY-CG40L600	0.6m	1.7W	>80	1200mA	665*150*230 (mm) 20pcs/ctn

Applications: Under And Over Cabinets, Display Cases, Task Lighting, Work Areas etc

Led T8 Tube Light

Classical Product, Global Reputation



Features

- ☑ Replacement Traditional Fluorescent T8 And T12 Lighting
- ☑ Energy Savings More Than 60%
- ☑ 0.8mm Aluminum Housing



Product Display



Product Line Drawing (Size:mm)

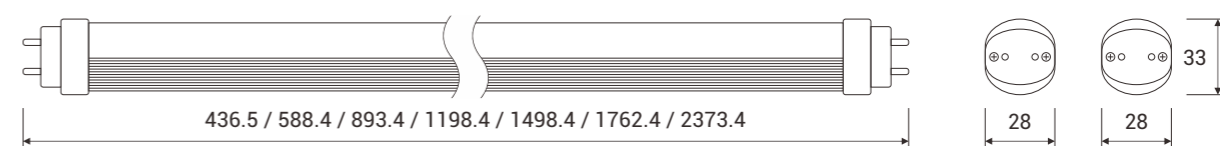

Connection Ways

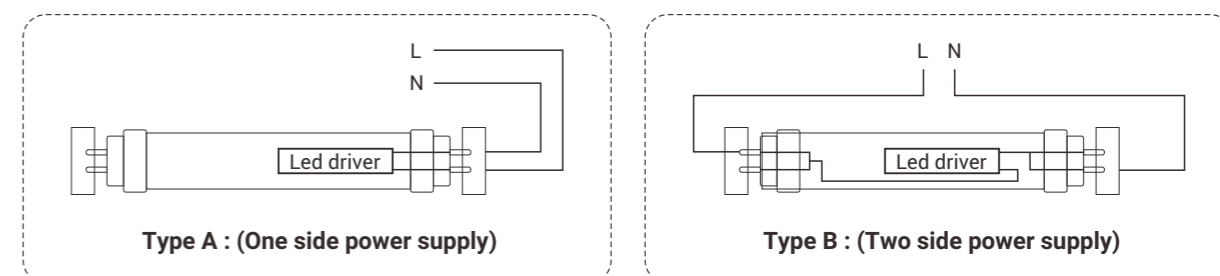

Product Specification

Material : AL+PC	PC Cover : Frosted / Clear	CCT : <input type="checkbox"/> 3000K <input type="checkbox"/> 4000K <input type="checkbox"/> 5000K <input type="checkbox"/> 6000K
------------------	----------------------------	-----------------------------------------------------------------------------------------------------------------------------------

Model	Size	Power	CRI	Beam Angle	Package
LY-T8L600-9W	2ft	9W	>80	120	670*340*200 (mm) 50pcs/ctn
LY-T8L900-13W	3ft	13W	>80	120	980*340*200 (mm) 50pcs/ctn
LY-T8L1200-9W	4ft	9W	>80	120	1280*275*200 (mm) 40pcs/ctn
LY-T8L1200-16W	4ft	16W	>80	120	1280*275*200 (mm) 40pcs/ctn
LY-T8L1200-18W	4ft	18W	>80	120	1280*275*200 (mm) 40pcs/ctn
LY-T8L1500-22W	5ft	22W	>80	120	1580*210*180 (mm) 30pcs/ctn
LY-T8L1800-28W	6ft	28W	>80	120	1845*210*180 (mm) 30pcs/ctn
LY-T8L2400-44W	8ft	44W	>80	120	2460*175*165 (mm) 20pcs/ctn

Applications: Supermarkets, Shopping Mall, Entertainment Venues, Factories etc



6CCT & 5Wattage T8 Tube

Suitable for your both retrofit project and new project



Features

- ☑ It is Type A+B, ballast compatible + AC direct input.
- ☑ 5Wattage: 10w 12w 15w 18w 24w
- ☑ 6CCT: 2700K 3500K 4000K 5000K 5700K 6500K

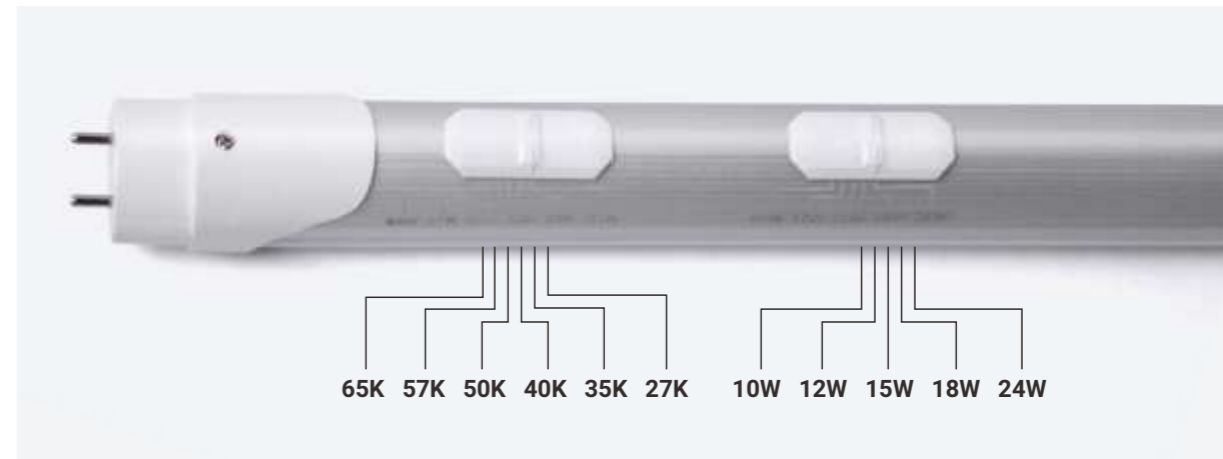

Product Line Drawing (Size:mm)

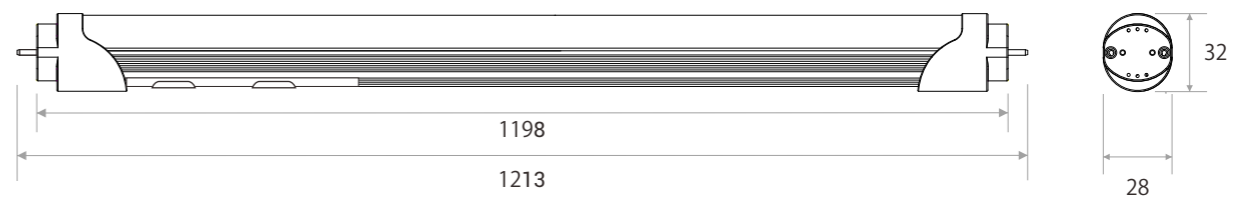

Product Specification

Material : AL+PC	PC Cover : Frosted / Clear	CCT : <input type="checkbox"/> 3000K <input type="checkbox"/> 4000K <input type="checkbox"/> 5000K <input type="checkbox"/> 6000K			
Model	Size	Power	CRI	Light Efficiency	Package
LY-T8L1200-18W	4ft	18W	>80	120lm/w	1280*275*200 (mm) 40pcs/ctn

Product Display



Applications: Supermarkets, Shopping Mall, Entertainment Venues, Factories etc

Led Downlight

3CCT DIP switchole with SAA approval for Australia markets



Features

- ☑ Matt white housing with frost white diffuser.
- ☑ Perfect for new or retro-fit installations with a standard 90mm hole cut-out.
- ☑ Easily change colour temperature (CCT)



Product Line Drawing (Size:mm)

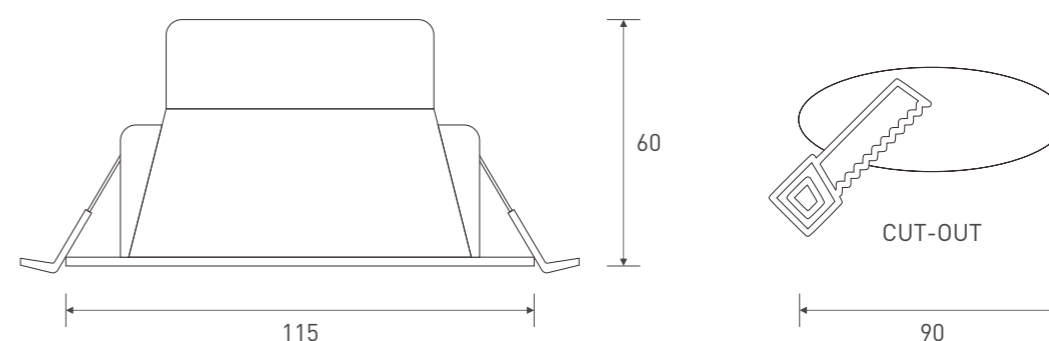

Product Specification

Material : AL+PC	PC Cover : Frosted	CCT : ■ 3000K ■ 4000K ■ 6000K		
Model	Size	Power	Dimming	Package
JH-FDL6-P9010-CCT	Ø115*H60	10W	X	420*280*375 (mm) 30pcs/ctn
LL-FDL6-P9010-CCT	Ø115*H60	10W	X	420*280*375 (mm) 30pcs/ctn
JH-RDL03-IC-P9010D-CCT	Ø115*H60	10W	✓	420*280*375 (mm) 30pcs/ctn

Product Display

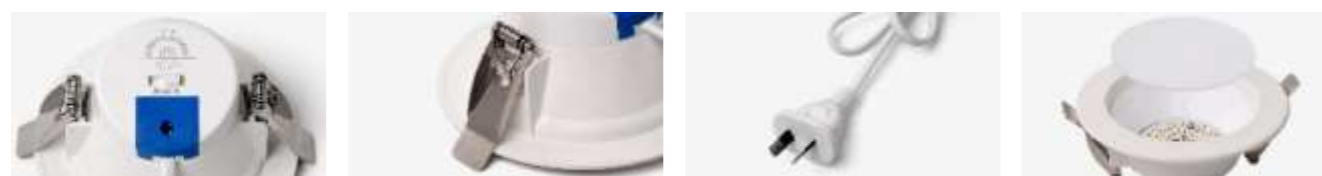

Applications: Supermarkets, Shopping Mall, Entertainment Venues, Factories etc

Solar Garden Light

These solar lights are small and simple enough that they can disappear into the landscape



- Features**
- ☑ 4 different options
 - ☑ Lithium Battery
 - ☑ 3CCT Tunable



Product Line Drawing (Size:mm)

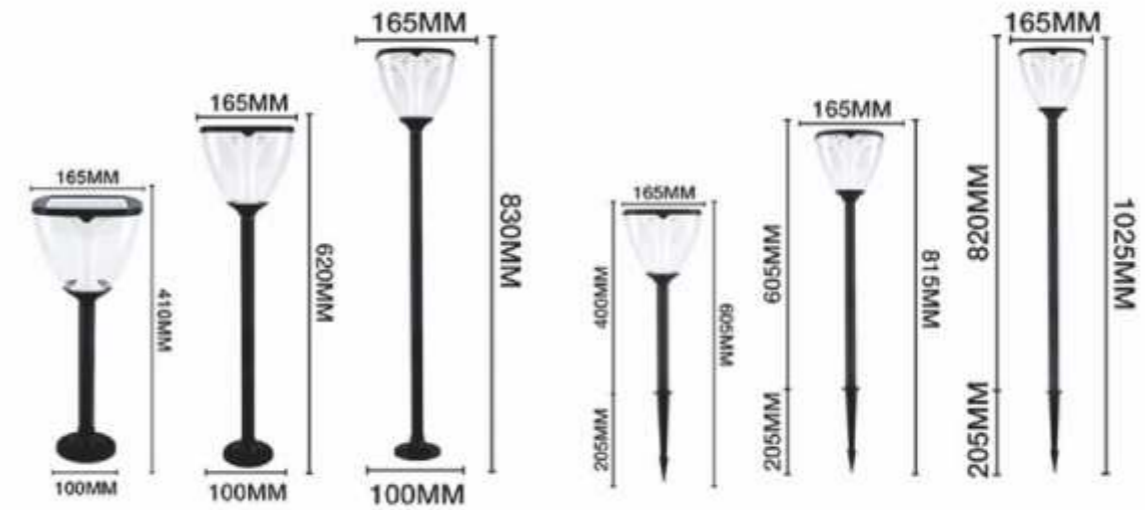

Applications



Led T8 Integrated Light

Classical Integrative Original Design From LONYUNG



Features

- ✓ Patent Male-female Linkable Design
- ✓ Seamless Connection
- ✓ Curved Lens Provides >120° Beam



Connection Ways



Standard Clip



Product Line Drawing (Size:mm)

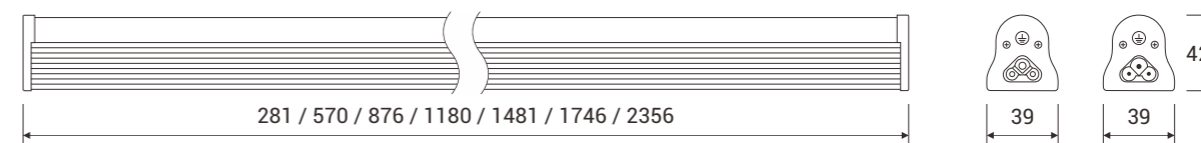

Product Specification

Material : AL+PC	PC Cover : Frosted / Clear	CCT : ■ 3000K ■ 4000K ■ 5000K ■ 6000K
------------------	----------------------------	--------------------------------------------------------------------------------------------------------------------------------------------------------------------------------------------

Model	Size	Power	CRI	Beam Angle	Package
LY-T8DL300-5W	1ft	5W	>80	120	435*240*205 (mm) 20pcs/ctn
LY-T8DL600-9W	2ft	9W	>80	120	725*240*205 (mm) 20pcs/ctn
LY-T8DL900-13W	3ft	13W	>80	120	1035*240*205 (mm) 20pcs/ctn
LY-T8DL1200-18W	4ft	18W	>80	120	1335*240*205 (mm) 20pcs/ctn
LY-T8DL1200-22W	4ft	22W	>80	120	1335*240*205 (mm) 20pcs/ctn
LY-T8DL1500-25W	5ft	25W	>80	120	1640*240*205 (mm) 20pcs/ctn
LY-T8DL1800-28W	6ft	28W	>80	120	1900*240*205 (mm) 20pcs/ctn
LY-T8DL2400-44W	8ft	44W	>80	120	2510*150*166 (mm) 9pcs/ctn

Applications: Storage, Retail And Grocery Store, Parking Lot etc



Single T5 Integrated Light (I)

Good Lighting Products, LONYUNG Created



Features

- ✓ Patent Male-female Linkable Design
- ✓ Seamless Connection
- ✓ Linkable Max 200w And 600W Version Fixing Clip



Product Line Drawing (Size:mm)

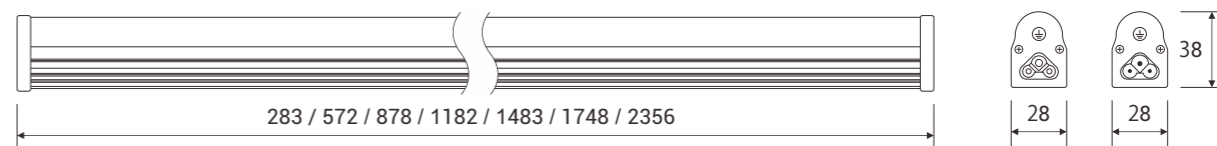

Product Specification

Material : AL+PC	PC Cover : Frosted / Clear	CCT : <input type="checkbox"/> 3000K <input type="checkbox"/> 4000K <input type="checkbox"/> 5000K <input type="checkbox"/> 6000K
------------------	----------------------------	-----------------------------------------------------------------------------------------------------------------------------------

Model	Size	Power	CRI	Beam Angle	Package
LY-T5DL300-4W	1ft	4W	>80	120	490*175*230 (mm) 25pcs/ctn
LY-T5DL600-7W	2ft	7W	>80	120	780*175*230 (mm) 25pcs/ctn
LY-T5DL900-12W	3ft	12W	>80	120	1085*175*230 (mm) 25pcs/ctn
LY-T5DL1200-15W	4ft	15W	>80	120	1390*175*230 (mm) 25pcs/ctn
LY-T5DL1500-20W	5ft	20W	>80	120	1690*175*230 (mm) 25pcs/ctn
LY-T5DL1800-22W	6ft	22W	>80	120	1955*175*190 (mm) 20pcs/ctn
LY-T5DL2400-30W	8ft	30W	>80	120	2565*175*145 (mm) 15pcs/ctn

Applications: Restaurant, Store, Supermarket, Display Rack etc

Connection Ways



Connection Cable



Standard Clip



Single T5 Integrated Light (II)

Great Performance, Reasonable Cost



Features

- ☑ Patent Male-female Linkable Design
- ☑ Seamless Connection
- ☑ CCT Adjustable Optional



Product Line Drawing (Size:mm)

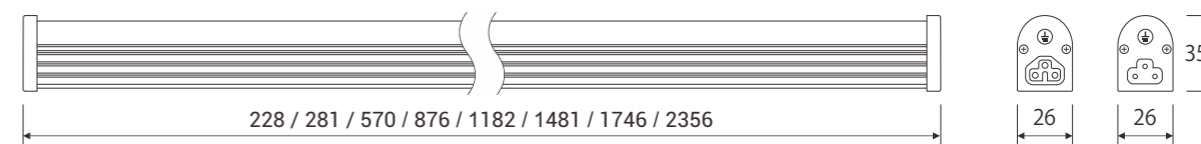

Product Specification

Material : AL+PC	PC Cover : Frosted / Clear	CCT : <input type="checkbox"/> 3000K <input type="checkbox"/> 4000K <input type="checkbox"/> 5000K <input type="checkbox"/> 6000K
------------------	----------------------------	-----------------------------------------------------------------------------------------------------------------------------------

Model	Size	Power	CRI	Beam Angle	Package
LY-T5DL222-4W	9in	4W	>80	120	490*175*230 (mm) 25pcs/ctn
LY-T5DL300-4W	1ft	4W	>80	120	490*175*230 (mm) 25pcs/ctn
LY-T5DL600-7W	2ft	7W	>80	120	780*175*230 (mm) 25pcs/ctn
LY-T5DL900-12W	3ft	12W	>80	120	1085*175*230 (mm) 25pcs/ctn
LY-T5DL1200-15W	4ft	15W	>80	120	1390*175*230 (mm) 25pcs/ctn
LY-T5DL1500-20W	5ft	20W	>80	120	1690*175*230 (mm) 25pcs/ctn
LY-T5DL1800-22W	6ft	22W	>80	120	1955*175*190 (mm) 20pcs/ctn
LY-T5DL2400-30W	8ft	30W	>80	120	2565*175*145 (mm) 15pcs/ctn

Applications: Home, Hotel, Kitchen, Task Lighting etc

Connection Ways



Straight Connector



Standard Clip





Double T5 Integrated Light (I)

Globally Original Double Tube Design, Elegant Appearance



Features

- ✓ Double Led Strip Design
- ✓ Excellent Brightness
- ✓ Linkable Max 200w And 600W Version Optional



- On/Off Switch
- Power On The Back
- Suspending Kits
- Standard Clip



••• Installation

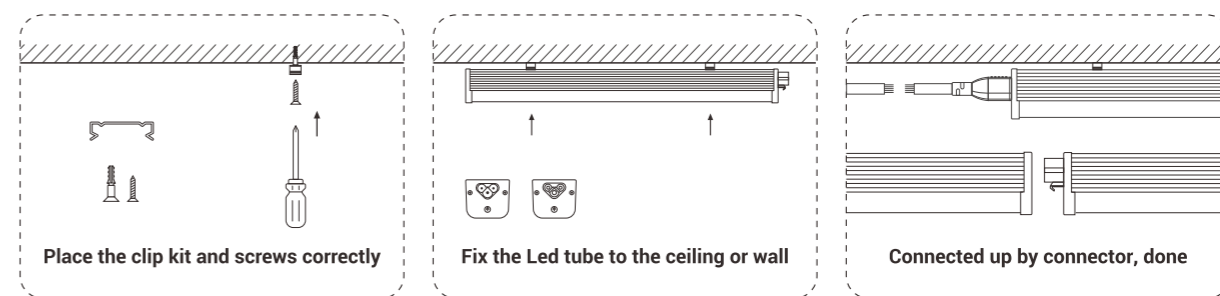

••• Product Line Drawing (Size:mm)

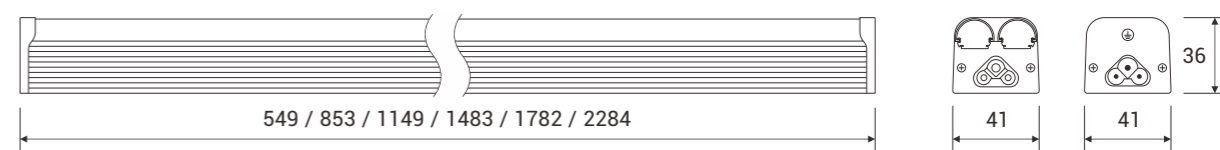

••• Product Specification

Material : AL+PC	PC Cover : Frosted / Clear	CCT : <input type="checkbox"/> 3000K <input type="checkbox"/> 4000K <input type="checkbox"/> 5000K <input type="checkbox"/> 6000K
------------------	----------------------------	-----------------------------------------------------------------------------------------------------------------------------------

Model	Size	Power	CRI	Beam Angle	Package
LY-T5SL600-15W	2ft	15W	>80	90 / 210	710*260*180 (mm) 20pcs/ctn
LY-T5SL900-25W	3ft	25W	>80	90 / 210	1015*260*180 (mm) 20pcs/ctn
LY-T5SL1200-30W	4ft	30W	>80	90 / 210	1310*260*180 (mm) 20pcs/ctn
LY-T5SL1200-40W	4ft	40W	>80	90 / 210	1310*260*180 (mm) 20pcs/ctn
LY-T5SL1500-40W	5ft	40W	>80	90 / 210	1645*210*180 (mm) 16pcs/ctn
LY-T5SL1800-44W	6ft	44W	>80	90 / 210	1945*210*180 (mm) 16pcs/ctn
LY-T5SL2400-60W	8ft	60W	>80	90 / 210	2445*160*146 (mm) 9pcs/ctn

••• Applications: Retail And Grocery Store, Warehouse, Factory, Workshop etc



Double T5 Integrated Light (II)

Classical Integrative Original Design From LONYUNG



Features

- ✓ Double Led Strip Design
- ✓ More Flatter And Slimmer
- ✓ Greater Light Angle (>180° Beam)



■ Connection Ways



■ Standard Clip



Product Line Drawing (Size:mm)

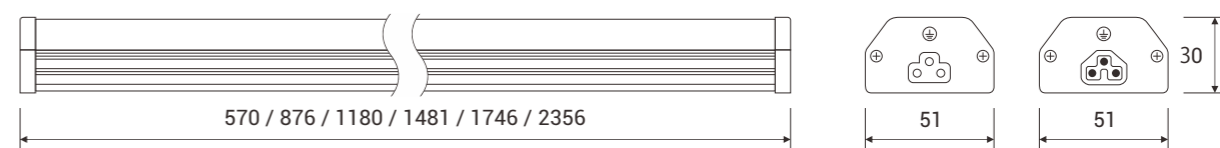

Wiring Method

Single Wired

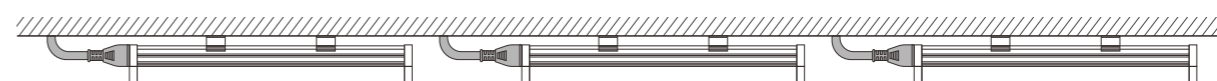

Linkable

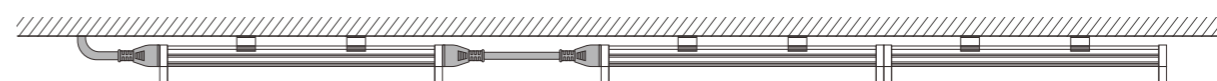

Product Specification

Material : AL+PC	PC Cover : Frosted / Clear	CCT : <input type="checkbox"/> 3000K <input type="checkbox"/> 4000K <input type="checkbox"/> 5000K <input type="checkbox"/> 6000K
------------------	----------------------------	-----------------------------------------------------------------------------------------------------------------------------------

Model	Size	Power	CRI	Beam Angle	Package
LY-T5SL600-15W	2ft	15W	>80	180	735*235*190 (mm) 20pcs/ctn
LY-T5SL900-25W	3ft	25W	>80	180	1045*235*190 (mm) 20pcs/ctn
LY-T5SL1200-30W	4ft	30W	>80	180	1345*235*190 (mm) 20pcs/ctn
LY-T5SL1200-40W	4ft	40W	>80	180	1345*235*190 (mm) 20pcs/ctn
LY-T5SL1500-40W	5ft	40W	>80	180	1645*235*155 (mm) 16pcs/ctn
LY-T5SL1800-44W	6ft	44W	>80	180	1910*235*155 (mm) 16pcs/ctn
LY-T5SL2400-60W	8ft	60W	>80	180	2520*180*120 (mm) 9pcs/ctn

Applications: Warehouse, Aisle, Shopping Center, Garage etc



reddot award
winner

Led Camping Lantern





Led Camping Lantern

Reddot Product Design Award, Cute Gift

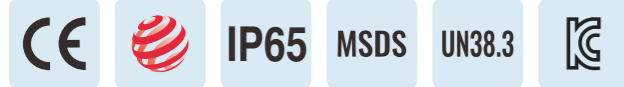

Features

- ☑ Shatter-resistant
- ☑ Ip65 Waterproof
- ☑ USB Charging



- 100% Lighting
- 20% Lighting
- Mosquito Repellent
- SOS
- Ip65



••• Charge Mode



••• Lighting

The Max. Luminous Flux of 100% Lighting	≥100Lm
The Max. Luminous Flux of 20% Lighting	≥20Lm
100% Lighting time after fully charged	≥4hours
20% Lighting time after fully charged	≥7hours

••• Specification

Input Voltage	5.2V	Input Current	200MA
Fully Charged Time	2Hours	Product Size	φ 80x70mm
Product Weight	102g±1g	Battery	1000mAH Li-ion Battery
Package	425x355x380mm 80pcs/ctn		

LONYUNG®
LED INTEGRATED LIGHT MANUFACTURER

LONYUNG LED LIGHTING CO.,LTD

Tel: 86-760-2218 2786

Fax: 86-760-2383 2030

E-mail: info@lonyung.com

Address: Block2, number 39, East Jucheng Rd, Xiaolan
Town, Zhongshan City, China

<https://www.lonyung.com>

<https://lonyung.en.alibaba.com>

<https://lonyungled.en.alibaba.com>

<https://zslonyung.1688.com/>

Lonyung Search

Copyright © LONYUNG 2010-2025